



TACTICAL
MEDICINE
PRODUCTS



COMPRESSION TOURNIQUET ZHK-01- "MEDPLANT" ZHK-02- "MEDPLANT"

TACTICAL
MEDICINE
PRODUCTS

ARREST OF
BLEEDING



The original compression tourniquet is a flat "Velcro" strap with a buckle. The tourniquet has a spool with two slings. Compression is achieved by moving the lever, which winds the slings onto the spool, tightens the flat strap, and arrests the bleeding. Each time the lever is turned, it automatically locks, unlike similar tourniquets. Also, this tourniquet offers a smoother twist and easier control.

Designed for effective arrest of external arterial bleeding.



- Causes minimal pain.
- Provides reliable arrest of blood flow, both for self-help and when assisted by others.
- Dosed compression.



Product details and specification

Dimensions when folded, mm: (110x50x60)±20
Weight, NMT, kg: 0,1

COMPRESSION TOURNIQUET ZHK-03- "MEDPLANT"

TACTICAL
MEDICINE
PRODUCTS

ARREST OF
BLEEDING



Disposable compression tourniquet ZHK-03 represents the flat band with "velcro" fastener. The rod mechanism is situated perpendicular to an arm which makes the stop bleeding procedure more comfortable. The updated modification of tourniquet has a rod situated extensionally that prevents spontaneous loosening and reduces the risk of soft tissue damage. It takes 3-5 turns to stop bleeding. It is designed for temporary stopping of massive, life-threatening bleeding in the lower and upper extremities.

Designed for effective arrest of external arterial bleeding.



- Causes minimal pain.
- Provides reliable arrest of blood flow, both for self-help and when assisted by others.
- Dosed compression.

Dimensions when folded, mm: (180±20)x(50±10)x(50±10)
Weight, NMT, g: 84±15



Product details and
specification

FASTENINGS AND POUCHES FOR COMPRESSION TOURNIQUETS

TACTICAL
MEDICINE
PRODUCTS

ARREST OF
BLEEDING



"UZH-01" tourniquet fastener is designed to secure folded tourniquets on vests, backpacks, pouches, etc.

Pouches for "UZH-02", "UZH-03", and "UZH-04" tourniquets are designed to easily accommodate and swiftly deploy tourniquets. Made from durable synthetic fabric, these pouches resist abrasion and withstand washing and cleaning.

Equipped with "Molle" fasteners.

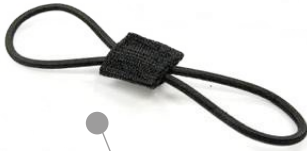

"UZH-01"

tourniquet fastener



"UZH-02"

tourniquet pouch



"UZH-03"

tourniquet pouch



"UZH-04"

tourniquet pouch



Product details and specification

BANDAGE SCISSORS

TACTICAL
MEDICINE
PRODUCTS

ARREST OF
BLEEDING

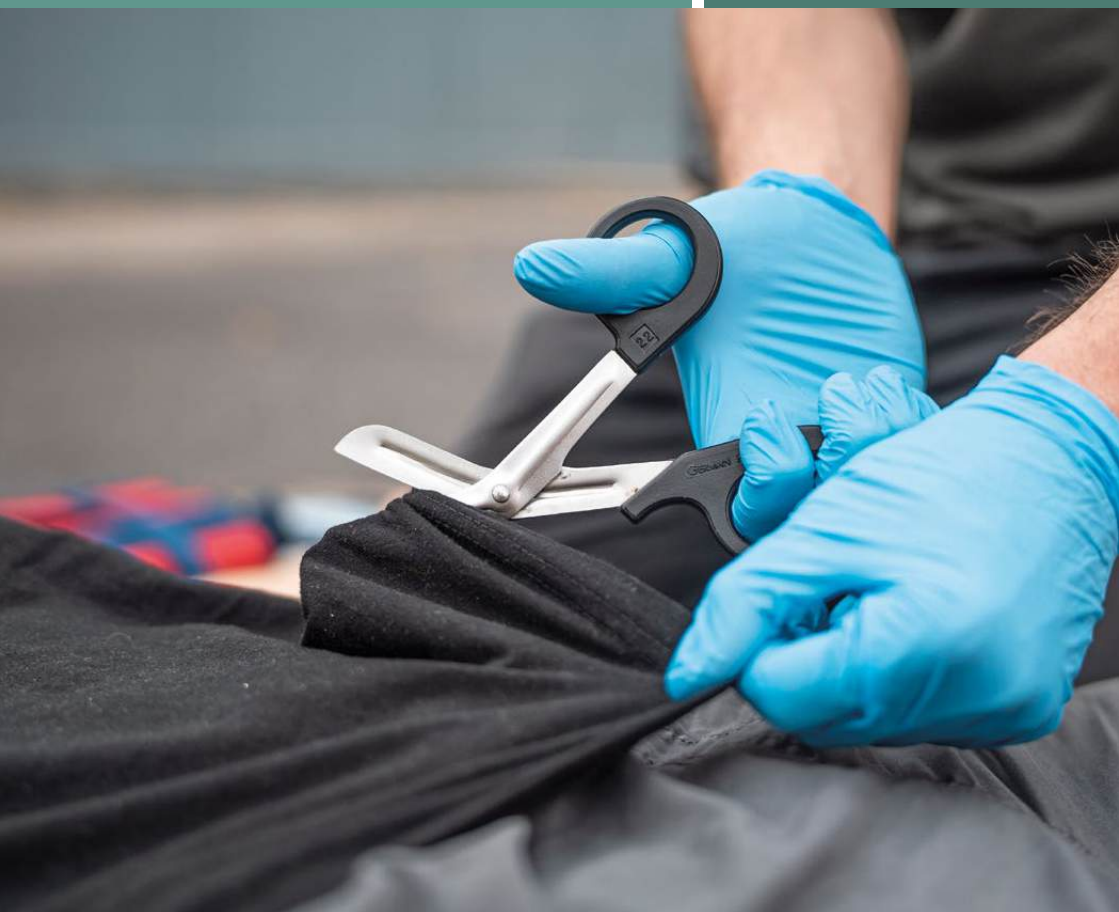

Bandage scissors (tactical scissors) are used in field medicine, by rescue services, trauma departments, in emergency rooms of medical centers, in disaster medicine.

Allow safe cutting of thin plaster casts, bandages, clothing, plastic and carton splints, duralumin-coated splints, belts, etc., made of various textile and polymer materials.



- Easy to cut even dense materials.
- Atraumatic design.
- Comfortable grip.

	Dimensions, mm:
SCR-6031	(180x90x8,7)±1,0
SCR-6030	(145x66x7,5)±1,0

Weight, g, NMT:
70
35



Product details and specification

SETS OF TRANSPORT
IMMOBILIZATION
FOLDABLE SPLINTS FOR
SINGLE USE
KSHTI-03-"MEDPLANT"

TACTICAL
MEDICINE
PRODUCTS

IMMOBILIZATION
AND MEDICAL
EVACUATION



These splints are specially shaped plastic plates with longitudinal and transverse perforations for easy customization to fit any limb length and diameter. The splints are fixed by means of bandages.

The splint-collar is designed to fit both the neck's circumference and height. The splint-collar is secured with a textile strip.

Ready-to-use multi-size foldable portable splints for immobilizing and transporting patients with cervical spine, upper and lower limb traumas.

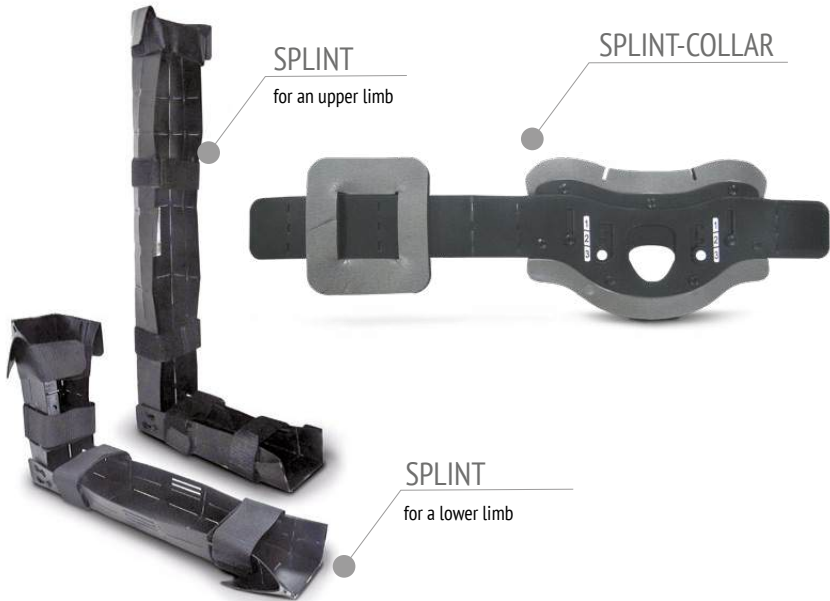

- Can be customized to fit any size.
- They perfectly mimic the limb's shape, fitting snugly without any extra steps.
- Lightweight and compact.
- X-ray transparent.

Splint set dimensions, mm: (350x150x70)±30
Weight, kg: 0,85



Product details and specification

SET OF TRANSPORT LADDER SPLINTS KSHTL-MP-01

TACTICAL
MEDICINE
PRODUCTS

IMMOBILIZATION
AND MEDICAL
EVACUATION



The set includes transportation ladder splints for the upper and lower limbs. The products are a PE-foam wire frame sheathed with a strong PVC fabric. Simply bend the splint where it fits the limb so that it mimics the limb's shape and secure with bandages.

Patients are protected from direct contact with metal, making the usage of transportation ladder splints even safer.

Immobilizing the upper and lower limbs during medical evacuation.



- Soft base.
- Comfortable cover for carrying.
- Easy to clean.

for an upper limb
for a lower limb

Dimensions, mm:
(860x120x20) ±10
(1240x150x20) ±10

Weight, kg:
0,35
0,6



Product details and
specification

FOLDABLE TRACTION LEG SPLINT SHTS-01-"MEDPLANT"

TACTICAL
MEDICINE
PRODUCTS

IMMOBILIZATION
AND MEDICAL
EVACUATION



The traction splint consists of 7 metal elbows securely joined in a sturdy framework.

The elbows are linked by a bungee cord, which allows the splint to be quickly brought into its working position. Below, the design features a limb extension system, equipped with a fixing foot strap. Above, there is a clamping system with a fixing groin strap. Adjustable straps along the splint's length restrain the leg effectively.

Immobilization of the lower limb with its simultaneous extension in case of femoral bone fracture. Studies conducted before and after traction have repeatedly shown the effectiveness of SHTS-01- "MEDPLANT" splints.



- Easy alignment during transportation.
- Easy to carry and quick to disassemble.

Dimensions incl. cover, mm: (380x110x100)±30
The splint's maximum length is NMT, mm: 1400
Weight incl. cover, NMT, kg: 1,5



Product details and
specification

PELVIC STABILIZATION BELT: REUSABLE PST- "MEDPLANT" / DISPOSABLE PSTo- "MEDPLANT"

TACTICAL
MEDICINE
PRODUCTS

IMMOBILIZATION
AND MEDICAL
EVACUATION



The immobilization belt consists of a base, strap and tightening loop. The base is crafted from natural cotton and neoprene, while the strap and loop are made of a sling. The belt features a color or digital scale to control its tightness during the belt application. The belt loop is intended for forced support during patient stabilization. The final retainer is a "Velcro" fastener.

Immobilization and stabilization of pelvic bones in case of unstable fractures and rupture of ligaments.

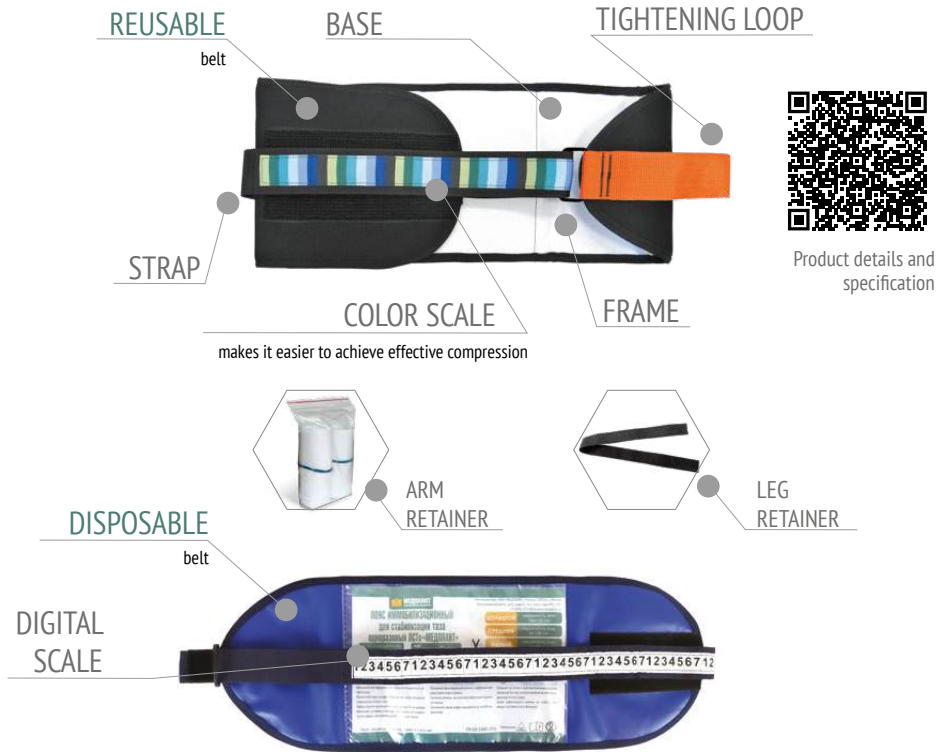

- Available in three sizes.
- Simplifies pelvic immobilization.

	large	medium	small
Base length, mm:	1000	800	600
Width, mm:	200	200	200
Weight, NMT, kg:	0,4	0,35	0,3



Product details and specification

FRAMELESS STRETCHERS "PLASCH"

TACTICAL
MEDICINE
PRODUCTS

IMMOBILIZATION
AND MEDICAL
EVACUATION



The stretcher canvas is crafted from a durable, low-maintenance material. It is water-resistant, impervious to moisture, and resistant to bacteria, fungi, stains and rot.

The stretcher comes with sturdy slings for patient fixation and ergonomic handles designed to evenly distribute the weight over the entire length.

Frameless stretchers are essential for the patients transporting in cramped or confined areas where traditional rigid stretchers cannot fit. All stretchers come with covers for easy storage.



- Compact, lightweight.
- The cover has a "Molle" fastener.



Product details and specification

EVACUATION SLEDGES "VOLOKUSHI", MODEL No.1/ MODEL No.2

TACTICAL
MEDICINE
PRODUCTS

IMMOBILIZATION
AND MEDICAL
EVACUATION



Evacuation sledges "VOLOKUSHI" are a flexible carrier with system of fixation straps. They slide smoothly over various surfaces that makes easier the evacuation process for rescuer and more comfort for patient.

The system of fixation straps provides a reliable patient stabilization and protects the patient during transportation.

Safe and reliable evacuation of wounded casualties unable to move independently during tactical or other emergencies.



**EVACUATION SLEDGES
"VOLOKUSHI", MODEL No.1**

(standard)

COVER

attachable to backpacks

**EVACUATION SLEDGES
"VOLOKUSHI", MODEL No.2**

(compact)

COVER

attachable to backpacks

- Quick to deploy, field-ready.
- Can be carried by a single rescuer.



Product details and specification

	standard	compact
Base size, mm:	2380x1000	2250x450
Dimensions incl. cover (Ø mm), mm:	1000x270x270	550x190x190
Weight, kg:	6,0	3,3

IMMOBILIZATION SPINE BOARD BOARD YXH-1A6A

TACTICAL
MEDICINE
PRODUCTS

IMMOBILIZATION
AND MEDICAL
EVACUATION



The spine board is made of durable colored PE, free of impurities and latex. The product materials withstand repeated sanitization and chemical disinfection, without compromising its appearance or durability. The spine board can be positioned on a medical stretcher or used with a vacuum mattress, or independently. The hole in the spine board, located at the patient's lower limbs, enables separate immobilization of the legs and thighs in case of fractures.

Immobilization and transportation of patients with injuries of the back, cervical spine, upper and lower limbs.

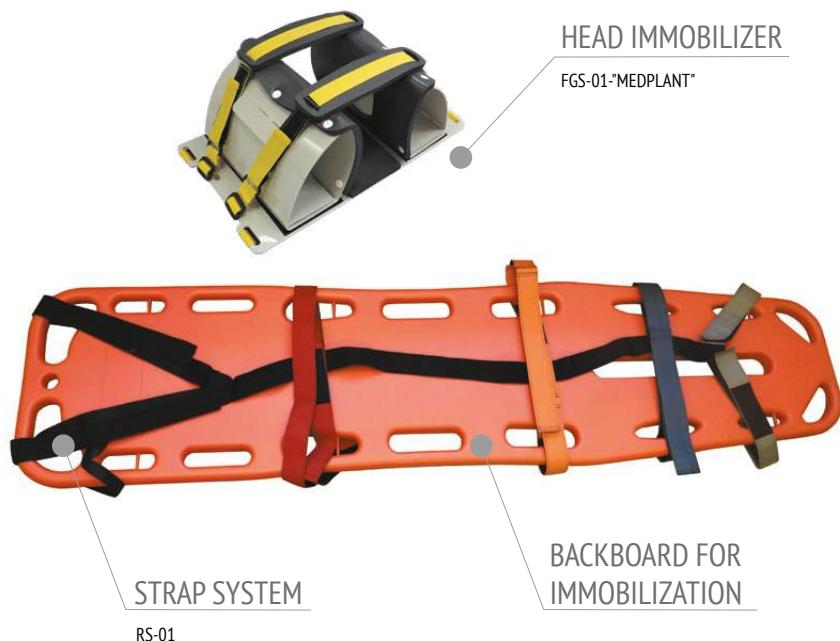

- The spine board is X-ray transparent.
- Floating allows it to be used in water rescue operations.
- Fast and comfortable fixation of the patient of any stature with the strap system owing to numerous holes on the spine board.

Set dimensions, NMT, mm: $(1830\pm 40)\times(450\pm 50)\times(50\pm 10)$
Weight, kg: 9,5



Product details and
specification

INJURED PERSONNEL CARRIER RUP- “MEDPLANT”

INCLUDED IN THE “VOLOKUSHI”
EVACUATION SLEDGES SET AND CAN
ALSO BE SUPPLIED SEPARATELY

TACTICAL
MEDICINE
PRODUCTS

IMMOBILIZATION
AND MEDICAL
EVACUATION



The device is a system of lockable straps to secure the injured on the rescuer's back. The device is designed with padded shoulder supports to ensure the rescuer's comfort. Straps can be easily adjusted to fit the patient's height using specialized buckles. To prevent improper securing of the patient, the control zones are clearly marked.

Easy-to-use compact device to secure victims on the rescuer's back.



Product details and specification

Length (at the extreme positions of length adjusters), mm:	1850
Strap length between length adjusters, mm:	1100
Width, mm:	50
Weight, NMT, g:	450

FIRST AID KIT (INDIVIDUAL) APPI- "MEDPLANT"

TACTICAL
MEDICINE
PRODUCTS

BAGS,
BACKPACKS



A set of medical devices for first aid providing. First aid kit is in a "Volunteer-7" pouch made of synthetic water-resistant fabric. The pouch features a convenient handle for fast opening and a removable panel with a "Molle" fastener. Inside the pouch there are elastic fasteners and pockets.

To provide first aid to an injured during emergency situations, as well as in natural and/or man-made emergencies.

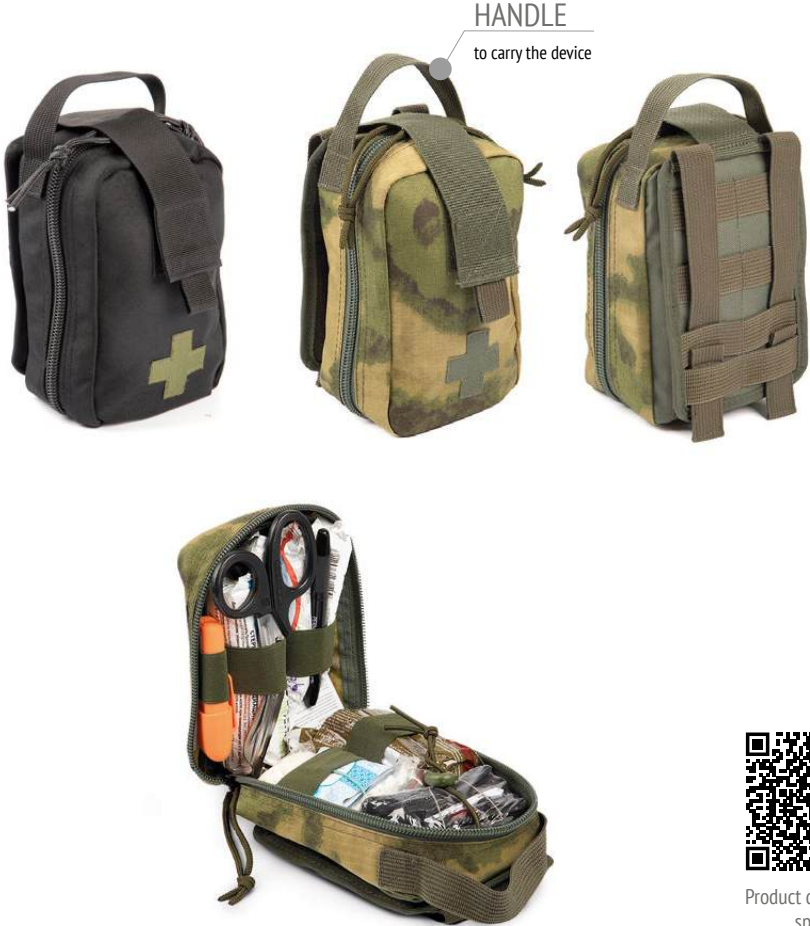

Product details and specification

FIRST AID KITS NPP

TACTICAL
MEDICINE
PRODUCTS

BAGS,
BACKPACKS



These are devices and accompanying products designed to provide first aid in crowded locations during major sporting events like the Olympics or FIFA World Cups, at open-air rock festivals and in any non-standard settings where prompt help can save a life before medical professionals arriving.

Providing first aid to civilians before specialized help arrives.

SUR-01



"VOLUNTEER-3"



"VOLUNTEER-4"



SURt-01



Product details and specification

UNIVERSAL BACKPACKS OF RVU SERIES

TACTICAL
MEDICINE
PRODUCTS

BAGS,
BACKPACKS



Universal backpacks RVU are made of durable and water-resistant "Cordura 1000D" synthetic fabric and engineered to withstand rigorous use and ensure longevity. Backpacks come with exterior and interior pockets, as well as detachable modular compartments to add convenience. Wide padded shoulder straps and handles ensure easy carrying.

A well-organized backpack provides fast and comfortable access to the contents of the kits.



Product details and specification

PRODUCTS FOR TACTICAL MEDICINE

UNIVERSAL BACKPACK RVU-01



Dimensions, mm: 410x190x610
Weight, kg: 2,8
* permitted deviation from the indicated values: 5%.

BACKPACKS OF RVU SERIES

All backpacks have a modular storage system.
The backpack RVU-02 comes with a trolley.

UNIVERSAL BACKPACK RVU-02



Dimensions with trolley, mm*: 550x330x1030
Dimensions without trolley, mm*: 400x310x810
Weight with trolley, NMT, kg: 8
Weight without trolley, NMT, kg: 5
* permitted deviation from the indicated values: 5%

PRODUCTS FOR TACTICAL MEDICINE

UNIVERSAL BACKPACK RVU-03



Dimensions, mm:

Weight, kg:

* permitted deviation from the indicated values: 5%.

MAIN BACKPACK
340x200x550*

3

SMALL BACKPACK
310x70x470*

1,4

SET
340x270x550

4,4

BACKPACKS OF RVU SERIES

The backpack RVU-03 features a self-discharge system and consists of two independent backpacks – small and large.

UNIVERSAL BACKPACK RVU-04



Dimensions, mm:

Weight, NMT, kg:

* permitted deviation from the indicated values: 5%.

410x270x530*

3

MANUAL ARTIFICIAL RESPIRATING UNIT ADR-MP

TACTICAL
MEDICINE
PRODUCTS

RESUSCITATION



Manual artificial respirating units (ADR) are designed to manually ventilate the lungs of adults (ADR-MP-V, patient weight is more than 15 kg), children (ADR-MP-D, patient weight is 4 - 15 kg) and newborns (ADR-MP-N, patient weight is not more than 4 kg) in conditions of respiratory failure of any etiology.

Manual resuscitators are a set of devices, accessories and instruments for manual resuscitation and ventilations.



The set includes:

- KD-MP-V manual resuscitator.
- Tongue holder.
- Screw mouth opener.
- Set of airways (3 pcs of different sizes).
- Fabric bag.
- APM-MP-1 mechanical aspirator with a set of aspiration catheters (optional).



Product details and specification

Dimensions, NMT, mm: (370x175x310)±20

Weight, NMT, kg: 3,5

CPR EFFICACY INDICATOR "TEMP"

TACTICAL
MEDICINE
PRODUCTS

RESUSCITATION



The CPR efficacy indicator "Temp" sets the frequency and depth of compressions during indirect cardiac massage by means of light and sound signals. The device is widely used in classrooms for training and exams for proper indirect cardiac massage conducting. The CPR indicator assists to rescuer by setting the correct rhythm and monitoring the depth of compressions during the resuscitation procedures.

Helps to perform optimal chest compressions throughout resuscitation, increasing the chances of preserving cerebral circulation and subsequent cardiac resuscitation using a defibrillator.



- Compact design.
- Quick to activate.
- Easy to operate.

Dimensions, NMT, mm: (90±5)x(60±5)x(21±2)
 Weight, NMT, g: 150



Product details and specification

PORTABLE SYRINGE DRIVER FOR MEDICINE "DSHP 5-20-SHMEL"

TACTICAL
MEDICINE
PRODUCTS

INFUSIONS



The main advantages of device - portability and autodetection of syringe volume. These features greatly simplify operations, allowing medical professionals to set just one parameter - the speed and the syringe driver is ready to use.

The compact design and light weight allow using this device everywhere: in clinics, in field conditions, during hospital transfers, on mobile medical units, in ambulances, etc.

The device is compatible with 5, 10 and 20 ml disposable syringes.

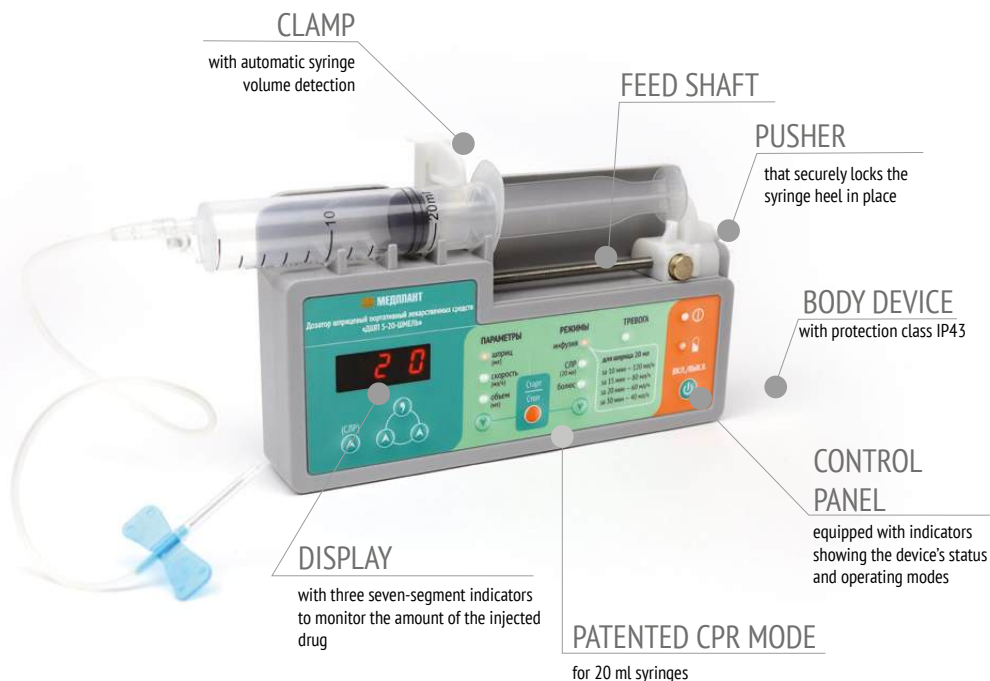

- Automatic detection of the nominal syringe volume (5 - 20 ml).
- CPR infusion mode for cardiopulmonary resuscitation.

Dimensions, mm: (167±5) x (92±5) x (32±5)
Weight, NMT, g: 300



Product details and
specification

FABRIC AMPOULE CASES OF AM SERIES

TACTICAL
MEDICINE
PRODUCTS

INFUSIONS



Fabric ampoule cases present a case made of durable, water-resistant PVC material. Each ampoule is securely placed in a separate slot made of elastic tape. AM-32 and AM-22 ampoule cases are securely fastened with a zipper, while AM-70 and AM-120 ones come with a "Velcro" fastener. The AM-22 ampoule case is designed for storage of ampoules with the reduced temperature maintenance between +2 °C and +8 °C.

Designed for placing, storage and transportation of ampoules in cases, medical bag or separately.



AM-22



AM-32



AM-70



AM-120



Product details and specification

	Dimensions, mm:	Weight, NMT,g:
AM-22	(145±10)x(195±15)x(35±5)	270
AM-32	(145±10)x(45±5)x(195±15)	300
AM-70	(205±15)x(150±10)x(70±10)	450
AM-120	(330±20)x(70±5)x(150±10)	800

PLASTIC AMPOULE CASES OF AP SERIES

TACTICAL
MEDICINE
PRODUCTS

INFUSIONS



Plastic ampoule case presents a case with such construction that provides good protection of ampoules. The AP-2 ampoule case is a compact case that holds seven ampoules of 1 and 2 ml, which can be stored even in the breast pocket of a medical gown. The AP-5 case features five slots designed for 5 ml ampoules.

Designed for placing, storage and transportation of ampoules in cases, medical bag or separately.



	Dimensions, mm:	Weight, NMT, g:
AP-2	$(82,8\pm 2)\times(16,7\pm 1)\times(87,5\pm 2)$	35
AP-5	$(84,5\pm 2)\times(21,1\pm 1)\times(105,5\pm 2)$	50

Product details and specification

CASE FOR PAIN MEDICATIONS

INFUSIONS



It is used for emergency medical care in stationary and field conditions, in medical vehicles, at home, outdoors, anywhere and anytime by medical staff who received the first aid training.

Designed for storage and transportation of pain medications.



- The container can be attached to clothing or placed in a first aid kit.
- A gentle touch of a finger effortlessly lifts the lid.
- Its bright color makes it quick and easy to find in your first-aid kit.
- It has trays for two syringe tubes.
- Reliably protects medicine packaging from damage.

Dimensions, mm: (100±3)x(35,4±2)x(26±2)
Weight, g: 15±0,75



Product details and
specification

FOLDING IV POLE SHR-"MEDPLANT"

TACTICAL
MEDICINE
PRODUCTS

INFUSIONS



Folding IV pole with a set of infusion vials holders is designed for infusion therapy in emergencies, in field conditions and at home. It provides strong stability while remaining compact. The clamping bracket can be attached to flat and cylindrical surfaces (up to 40 mm), particularly on stretchers.

The folding IV pole has the exceptional stability under unevenly distributed loads.



- Collapsible design with a folding base.
- Includes removable holders and hooks.
- Can be attached to stretchers, trolleys, tables and other surfaces.

Dimensions incl. cover, NMT, mm: 450x150x100
Weight, kg: 2



Product details and specification

SET OF INFUSION VIALS HOLDERS DF-"MEDPLANT"

TACTICAL
MEDICINE
PRODUCTS

INFUSIONS



The set contains two fabric holders of infusion vials and two metal S-shaped brackets. Vial is hanged on one end of bracket, another end is fixed to any suitable surface (car console, cart frame, bed back and so on).

The holders come in two sizes: for 200 and 400 ml vials and present the special construction made of pack tape with hook and loops for the vials fixation.



- Can be attached to any suitable surface.
- Color-coded sizes of vials: blue for 200 ml and black for 400 ml.
- Cover included.



Product details and specification

Dimensions incl. cover, mm: 120x170x40
Weight, kg: 0,1

PORTABLE RESUSCITATION CO₂/SPO₂ MONITOR "CAPNOPULSE"

TACTICAL
MEDICINE
PRODUCTS

MONITORING



Capnography channel (main stream): EtCO₂, FiCO₂ and respiratory rate monitoring, capnogram display. Pulse oximetry channel: SPO₂ and pulse rate monitoring, photoplethysmogram display, indication of low perfusion levels.

It can be powered by a battery, 220 V network and car lighter socket.

Real-time monitoring of physiological parameters.



Product details and specification

PORTABLE RESUSCITATION CO₂ MONITORS "CAPNOTEST"/ "CAPNOTEST-2"/ "MINICAP"

TACTICAL
MEDICINE
PRODUCTS

MONITORING



EtCO₂, FiCO₂ and respiratory rate monitoring, capnogram display.

Functions and interface are intended for emergency medical care. These devices can be used for tracheal intubation control; evaluating the resuscitation effectiveness; the ventilation providing and control; resuscitation monitoring during patient transportation.

Monitoring the carbon dioxide levels in the main stream.



PORTABLE
RESUSCITATION SPO₂
MONITORS
(PULSE OXIMETERS)
"OXITEST-1"/"OXITEST-2"

TACTICAL
MEDICINE
PRODUCTS

MONITORING



SPO₂ and pulse rate monitoring, photoplethysmogram display, indication of low perfusion levels. Functions and interface are intended for emergency medical care. It can be powered by a battery, 220 V network and car lighter socket. The "gold standard" of pulse oximetry - time-tested reliability and accuracy.

Saturation and pulse rate monitoring.



"OXITEST-1"

SENSOR

for adults: "clip" and "soft" models,
for newborns: "cuff" model



"OXITEST-2"



Product details and specification



MEDICAL DEVICES
FOR EMERGENCY CARE



MEDPLANT, LLC
42 Volgogradsky Prospect, build. 5,
109316, Moscow, Russia,
Technopolis "Moscow"
Tel.: +7 (495) 223-60-16, www.medplant.ru

The quality management system is certified for compliance with ISO 13485, ISO 9001

This mini-catalog is a reference guide intended only for specialists. It does not replace the operating manuals and detailed product descriptions on our website www.medplant.ru.

For detailed product information, including availability, cost and configuration, please contact our managers:
+7 495 223 60 16, +7 495 223 66 38.